

ALUTRUSS QUADLOCK QL-ET34-2000 Traversa a 4 punti

Sistema di traverse a 4 punti

Art.n.: 60306758

GTIN: 4026397501698

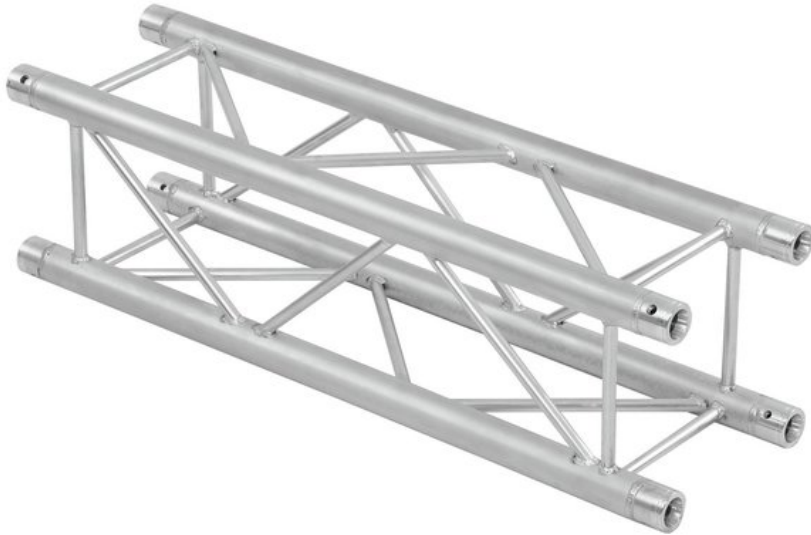

Prezzo di listino: 343.91 €

incl. 19% IVA

Descrizione :

QUADLOCK QL-ET34 4-point truss system

QUADLOCK QL-ET34 is a 4-point truss system made of aluminum. The individual elements are connected via four cones, pivots and pins. QUADLOCK QL-ET34 is made of EN-AW 6082 T6 (AlMgSi1 T6) alloy for even higher loads.

The advantage of the conical connection system is that the cones completely fit into the main chords so that highest load capacity is guaranteed. The Quick-Lock system enables fast, efficient and highly aesthetic assembly when the truss constructions are frequently assembled and dismantled.

The four main chords are made of 50 mm aluminum tube with 2 mm wall thickness and offer a good relation between strength and weight. The braces have a diameter of 20 mm with 2 mm wall thickness and provide stability for this truss system.

With 290 mm outer dimensions, QUADLOCK QL-ET34 is a stable truss system for higher loads and extended durability. This system is mainly designed for intense use in stage installations, fair installations, event installations but also for permanent installations in discotheques and theatres.

Its polished surface makes this universal system a real eyecatcher. Due to its wide range of standard system lengths, corners and accessory, this system is highly versatile and offers unlimited design possibilities.

The production of this truss system is TUV-monitored. The load table as calculation base can be downloaded from the Internet before buying the product! ALUTRUSS elements are made in Europe and welded by specially trained welders certified by the German SLV association.

Please note: this truss system must never be combined with other systems!

Logistica

EAN / GTIN: 4026397501698

Peso : 12,80 kg

Lunghezza : 2.00 m

Larghezza : 0.30 m

Altezza : 0.30 m

Merci voluminose

Features :

- Lega solida EN-AW 6082 per un'elevata resistenza
- Tubi in alluminio di alta qualità con un diametro di 50 mm
- Peso leggero
- Distanza centro foro - centro foro: 240 mm
- Montaggio facile
- Tubo della cinghia: 50 mm
- Made in Europe
- Per campi di applicazione come, ad esempio,: Teatro; Allestimenti per fiere e negozi; club/scuole di danza
- Per maggiori informazioni su questo prodotto, consultare "Download" nella scheda tecnica

Dotazione della fornitura

- 1 x set di connettori

Dati tecnici :

Struttura:	Montaggio facile
Tubo della cinghia:	50 mm x 2 mm
Processo di saldatura:	Impulso TIG
Materiale di saldatura:	AlMg 5
Materiale del tubo:	AlMgSi1 T6
Colore:	Color alluminio
Misure:	Lunghezza: 200 cm Larghezza: 29 cm Altezza: 29 cm
Peso:	11,2 kg